

PROJECT NO. 104-0510
rev# 1 6.21.2010

FRIENDS OF THE RIVERFRONT
33 TERMINAL WAY
PITTSBURGH, PA 15212

SIGN REPAIRS/REPLACEMENT



SIGNPRO
Architectural Sign Systems

483 BROWNSDALE RD. RENFREW, PA 16053
ph 724.586.5600 | fax 724.586.5699

www.signproinc.com

Please review each drawing and check the appropriate box.

Please make all corrections and notes on the corresponding drawing.

If there are no changes, check the first box. Changes not requiring a new drawing, check the second box.

Changes requiring a new drawing, check the third box.

Finally sign and date at the bottom.

PROJECT NO. **104-0510**

rev#1 6.24.2010

Dwg's & Pg #'s

Approved As Is
No Changes

Approved As
Noted

Requesting
New Drawing w/
Corrections

FILENAME: 104-0510 Prod Dwg.cdr

- | | | | |
|-----------------------------------|--------------------------|--------------------------|--------------------------|
| • Type 'P1' Typical / sheet#1 | <input type="checkbox"/> | <input type="checkbox"/> | <input type="checkbox"/> |
| • Type 'P1' Production1 / sheet#2 | <input type="checkbox"/> | <input type="checkbox"/> | <input type="checkbox"/> |
| • Type 'R1' Typical / sheet#3 | <input type="checkbox"/> | <input type="checkbox"/> | <input type="checkbox"/> |
| • Type 'R1' Production / sheet#4 | <input type="checkbox"/> | <input type="checkbox"/> | <input type="checkbox"/> |
| • Type 'R1' Production / sheet#5 | <input type="checkbox"/> | <input type="checkbox"/> | <input type="checkbox"/> |

NOTE -

• DRAWINGS MARKED '**TYPICAL**' REPRESENT THE STANDARD METHOD OF PRODUCTION AND ALL COLORS, MATERIALS AND SPECIFICATIONS FOR THAT PARTICULAR SIGN TYPE. WHEN APPROVING DRAWINGS MARKED 'TYPICAL' YOU ARE CONFIRMING THE OVERALL LAYOUT OF THE SIGN TYPE ALONG WITH ALL MATERIAL, COLOR CHOICES, SIZES , ETC MOST OFTEN WITH A TYPICAL DRAWING, ANY COPY OR GRAPHICS ARE USED AS PLACEHOLDERS FOR THE FINAL SIGN COPY.

• DRAWINGS MARKED '**PRODUCTION**' ARE USED TO REVIEW AND APPROVE ALL OF THE ACTUAL COPY AND GRAPHICS ON EACH INDIVIDUAL SIGN. FLOOR NUMBERS, SYMBOLS AND NAMES ARE PLACED AND LAID OUT AS THEY WILL APPEAR ON THE FINISHED SIGN. APPROVING A DRAWING MARKED 'PRODUCTION' MEANS YOU HAVE CHECKED AND APPROVE ALL INFORMATION ON EACH INDIVIDUAL SIGN.

IMPORTANT - PLEASE READ!

These drawings are submitted for your approval and were drawn with information provided by the client. Please review the drawings carefully and note any changes or corrections that may be required. Please double check all measurements, spelling, colors and sizes accurately. Also compare against your original SignPRO quote to verify items, quantities and materials. A signed and dated set of drawings is required for production to begin. If you require changes or corrections, please note on the drawing the revision(s) necessary and if production can proceed with change(s) noted, or if you require a new drawing reflecting the change(s).

Once a drawing has been signed and placed into production, any requested changes or omissions will be the responsibility of the client.

Please be thorough and contact your SignPRO representative or the Project Manager listed above if you have any questions regarding these drawings. Your signature means that you have reviewed each drawing and have approved all of the information. Drawings marked approved will be used for production and will supercede any other drawing.

Your timely response is critical in keeping an efficient production schedule and any deadlines regarding your installation. SignPRO is not responsible for delays in production or installation due to customer's inability to provide a timely approval of these drawings.

Thank you.

Signature

Date

TYPICAL

FRIENDS FO THE RIVERFRONT
33 TERMINAL WAY
PITTSBURGH, PA 15212

SIGN REPAIR/REPLACEMENT

PROJECT NO. 104-0510

TYPE: P1
Qty: 2
Size: noted
Face Mat: aluminum
Face Color: see details
Backer Mat: na
Backer Color(s): na
Graphics: vinyl
Graphic Color(s): see details
Font(s): Gothic 13
Mounting: direct burial/footer

Notes:

CONSTRUCTION DETAIL:

A. SEE DRAWING FOR DETAILS

Notes: Notes:

Drawn by: TMC Checked by: TMC
Date: 6.23.2010

Filename: 104-0510 Prod Dwg.cdr

Revision(s): 1
Version: 1

SIGN TYPE: P1

SHEET NO. 1

ON SINGLE SIDED SIGNS - REVERSE (BLANK) SIDE IS PAINTED SOLID RED PMS 1805C
DOUBLE SIDED SIGNS CARRY SAME TWO COLOR PATTERN OVER TO THE REVERSE SIDE

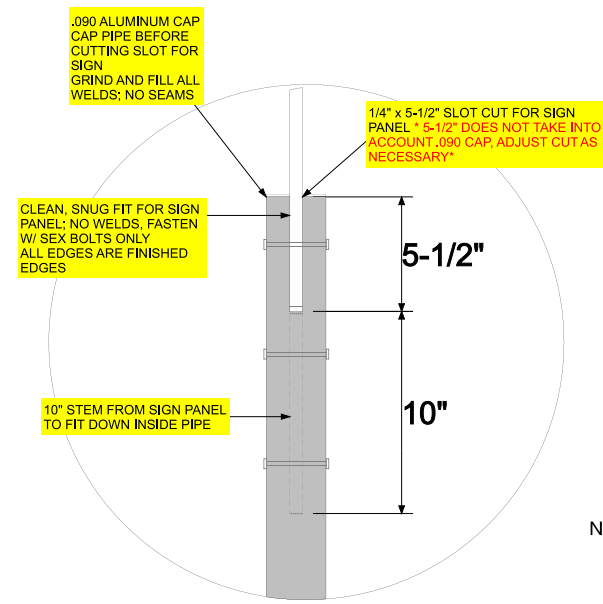
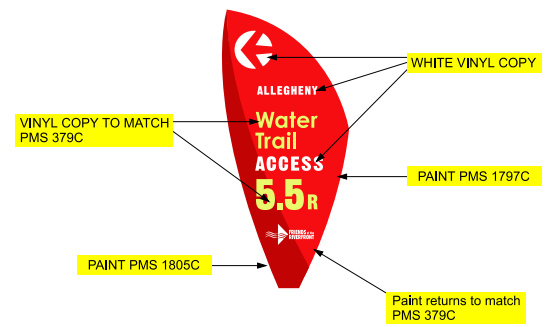
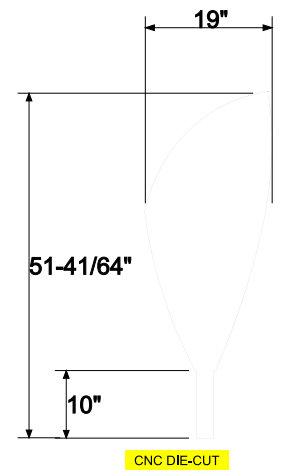

Concrete footer
NOTE: Foundation to be buried at least 3' deep

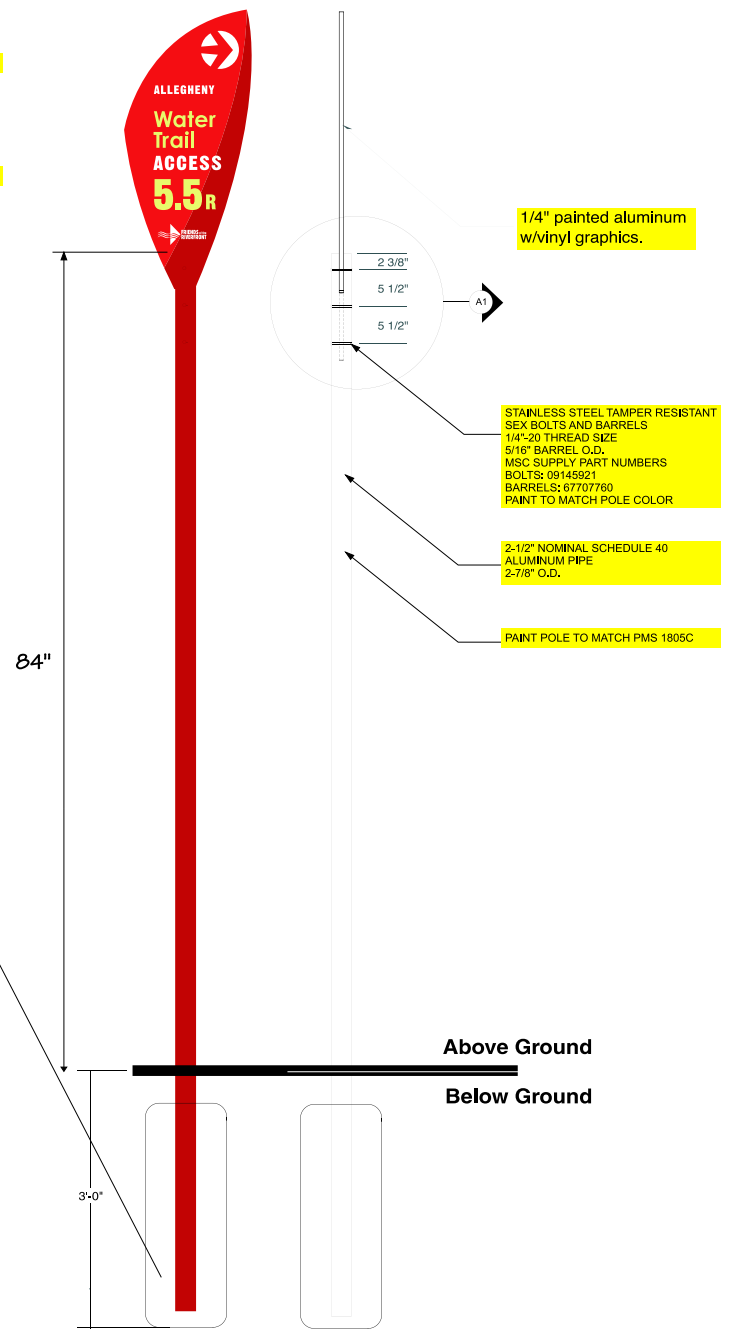

THIS DRAWING CONTAINS CONFIDENTIAL AND PROPRIETARY INFORMATION OF SIGNPRO, INC. AND MAY NOT BE REPRODUCED, REDESIGNED OR DISTRIBUTED WITHOUT PRIOR WRITTEN CONSENT FROM THE DESIGNER OR SIGNPRO, INC.

THIS DRAWING CONTAINS CONFIDENTIAL AND PROPRIETARY INFORMATION OF SIGNPRO, INC. AND MAY NOT BE REPRODUCED, REDESIGNED OR DISTRIBUTED WITHOUT PRIOR WRITTEN CONSENT FROM THE DESIGNER OR SIGNPRO, INC.

PRODUCTION



483 BROWNSDALE RD. RENFREW, PA 16053
ph 724.586.5600 fax 724.586.5699
www.signproinc.com

FRIENDS FO THE RIVERFRONT
33 TERMINAL WAY
PITTSBURGH, PA 15212

SIGN REPAIR/REPLACEMENT

PROJECT NO. 104-0510

TYPE: P1

Qty: 2
Size: noted
Face Matl: aluminum
Face Color: see details
Backer Matl: na
Backer Color(s): na
Graphics: vinyl
Graphic Color(s): see details
Font(s): Gothic 1.3
Mounting: direct burial/footer

Notes:

CONSTRUCTION DETAIL:

A. SEE DRAWING FOR DETAILS

Notes: Notes:

Drawn by: TMC Checked by: TMC
Date: 6.23.2010

Filename: 104-0510 Prod Dwg.cdr

Revision(s): 1
Version: 1

SIGN TYPE: **P1**

SHEET NO. **2**



CHAPEL HARBOR,
O'HARA TWP., ALLEGHENY RIVER

ITEM# 3 ON PRODUCTION ORDER



SEWICKLEY
RIVERFRONT PARK, OHIO RIVER, WALNUT ST.

ITEM# 5 ON PRODUCTION ORDER

TYPICAL

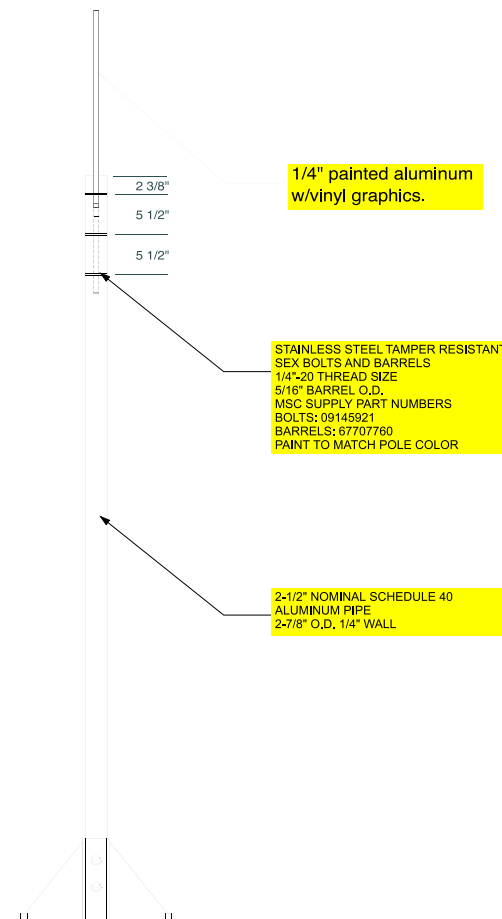
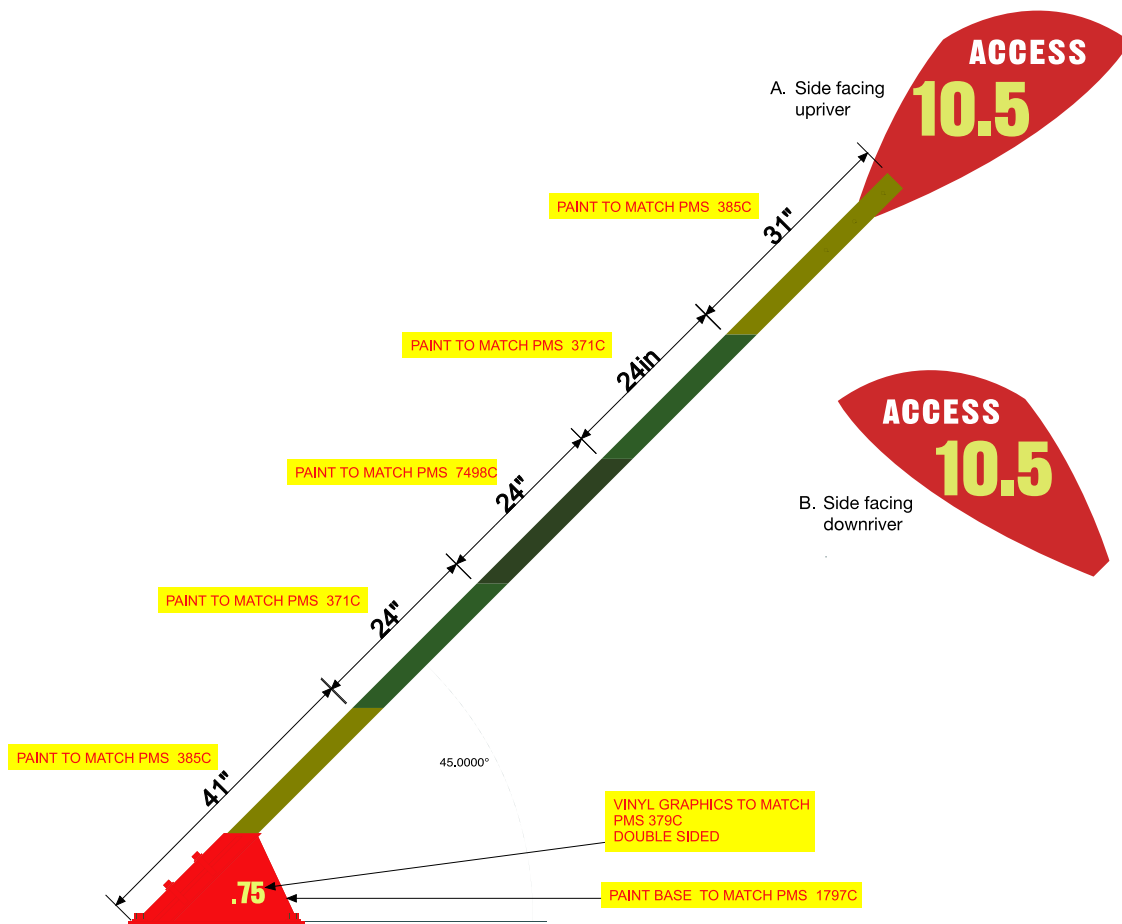

FRIENDS FO THE RIVERFRONT
33 TERMINAL WAY
PITTSBURGH, PA 15212

SIGN REPAIR/REPLACEMENT

PROJECT NO. 104-0510

TYPE: R1

Qty: 2
Size: noted
Face Mat: aluminum
Face Color: see details
Backer Mat: na
Backer Color(s): na
Graphics: vinyl
Graphic Color(s): see details
Font(s): Gothic 13
Mounting: concrete anchor

Notes:

CONSTRUCTION DETAIL:

A. SEE DRAWING FOR DETAILS

Notes: Notes:

Drawn by: TMC Checked by: TMC
Date: 6.23.2010

Filename: 104-0510 Prod Dwg.cdr

Revision(s): 1
Version: 1

SIGN TYPE: **R1**

SHEET NO. **3**

THIS DRAWING CONTAINS CONFIDENTIAL AND PROPRIETARY INFORMATION OF SIGNPRO, INC. AND MAY NOT BE REPRODUCED, REDESIGNED OR DISTRIBUTED WITHOUT PRIOR WRITTEN CONSENT FROM THE DESIGNER OR SIGNPRO, INC.

PRODUCTION

A. Side



B. Side



WESTHALL ST., CITY OF PITTSBURGH
WALNUT ST.

ITEM# 4 ON PRODUCTION ORDER

A. Side



B. Side



SEWICKLEY
RIVERFRONT PARK, OHIO RIVER, WALNUT ST.

ITEM# 5 ON PRODUCTION ORDER



483 BROWNSDALE RD. RENFREW, PA 16053
ph 724.586.5600 fax 724.586.5699
www.signproinc.com

FRIENDS FO THE RIVERFRONT
33 TERMINAL WAY
PITTSBURGH, PA 15212

SIGN REPAIR/REPLACEMENT

PROJECT NO. 104-0510

TYPE: R1

Qty: 2
Size: noted
Face Matl: aluminum
Face Color: see details
Backer Matl: na
Backer Color(s): na
Graphics: vinyl
Graphic Color(s): see details
Font(s): Gothic 1.3
Mounting: direct burial/footer

Notes:

CONSTRUCTION DETAIL:

A. SEE DRAWING FOR DETAILS

Notes: Notes:

Drawn by: TMC Checked by: TMC
Date: 6,23,2010

Filename: 104-0510 Prod Dwg.cdr

Revision(s): 1
Version: 1

SIGN TYPE: R1

SHEET NO. 4

TYPICAL

FRIENDS FO THE RIVERFRONT
 33 TERMINAL WAY
 PITTSBURGH, PA 15212

SIGN REPAIR/REPLACEMENT

PROJECT NO. 104-0510

TYPE: R1

Qty: 2
 Size: noted
 Face Mat: aluminum
 Face Color: see details
 Backer Mat: na
 Backer Color(s): na
 Graphics: vinyl
 Graphic Color(s): see details
 Font(s): Gothic 13
 Mounting: direct burial/footer

Notes:

CONSTRUCTION DETAIL:

A. SEE DRAWING FOR DETAILS

Notes: Notes:

Drawn by: TMC Checked by: TMC
 Date: 6.23.2010

Filename: 104-0510 Prod Dwg.cdr

Revision(s): 1
 Version: 1

SIGN TYPE: R1

SHEET NO. 5

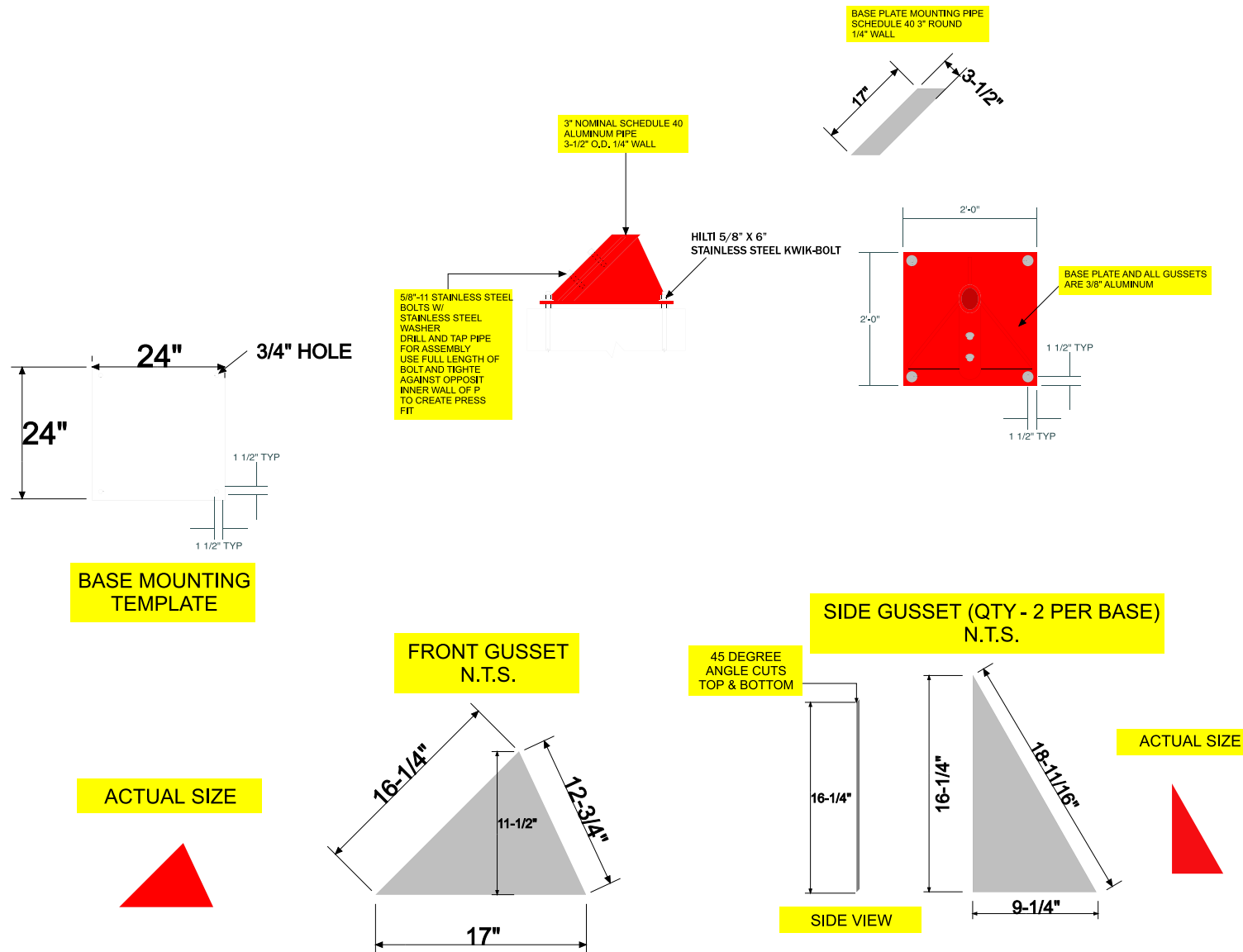

THIS DRAWING CONTAINS CONFIDENTIAL AND PROPRIETARY INFORMATION OF SIGNPRO, INC. AND MAY NOT BE REPRODUCED, REDESIGNED OR DISTRIBUTED WITHOUT PRIOR WRITTEN CONSENT FROM THE DESIGNER OR SIGNPRO, INC.